

Brake linings

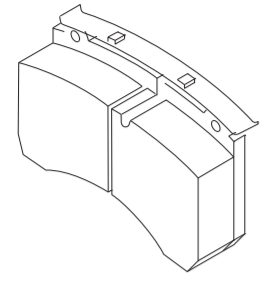

KNORR

Part No.	Description
3 057 0078 00	KNORR 19.5" SB/SN6
3 057 0077 00	KNORR 22.5" SB/SN7
3 057 0085 00	KNORR 22.5" SK7

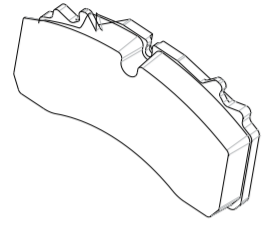

WABCO

Part No.	Description
3 057 0080 00	WABCO 19.5"
3 057 0084 00	WABCO 22.5"

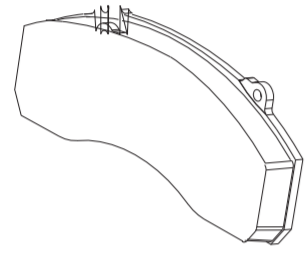

HALDEX

Part No.	Description
3 057 3179 00	HALDEX 22.5"

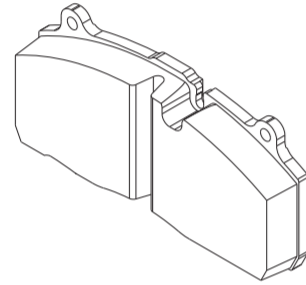

SAF

Part No.	Description
3 057 0096 00	SBS 2220

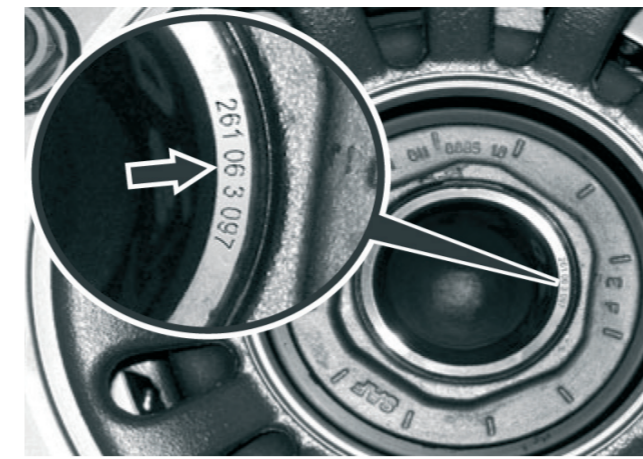

Production no. / Serial no. of axle on
RH of stub (in direction of travel)

DDYYXNNN

DDD = Day of manufacture

YY = Year of manufacture

X = Site*

NNN = Running number per day, year and place

New axle type plate from 25.07.2009

XXYYDDNNNN

XX = Place of manufacture

YY = Year of manufacture

DDD = Day of manufacture

NNNN = Running number per day, year and place

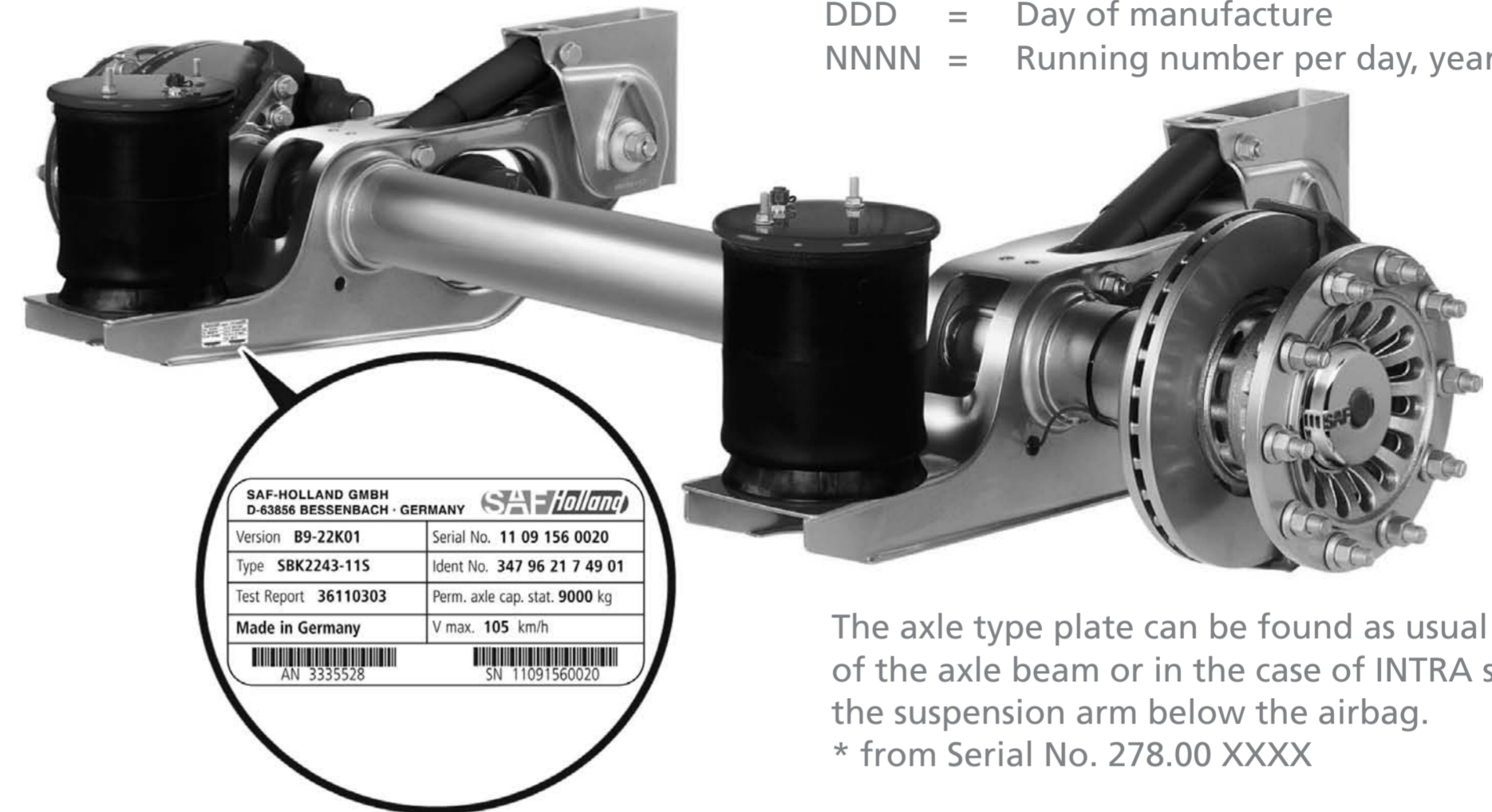

SAF-HOLLAND GMBH D-63856 BESSENBACH · GERMANY	
Version B9-22K01	Serial No. 11 09 156 0020
Type SBK2243-11S	Ident No. 347 96 21 7 49 01
Test Report 36110303	Perm. axle cap. stat. 9000 kg
Made in Germany	V max. 105 km/h
AN 3335528	SN 11091560020

The axle type plate can be found as usual in the middle of the axle beam or in the case of INTRA suspensions on the suspension arm below the airbag.

* from Serial No. 278.00 XXXX

Information! Drum

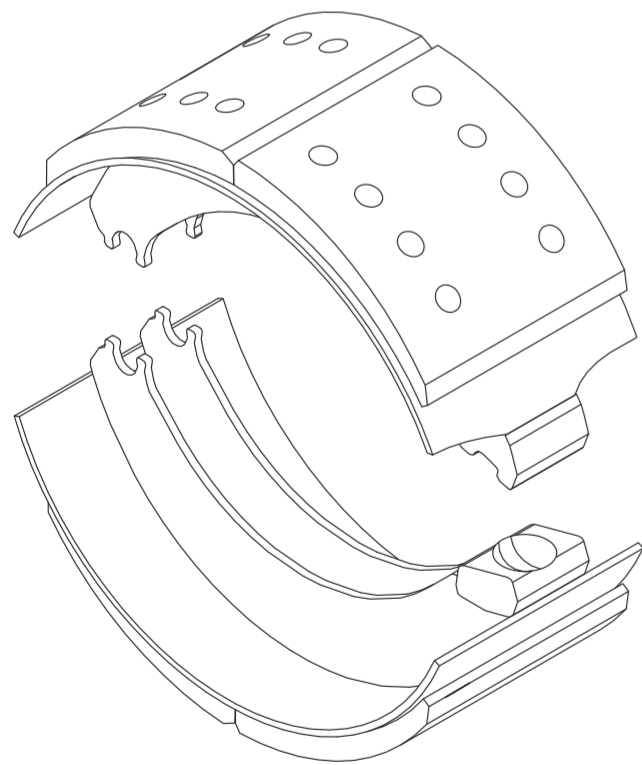

Part No.	Description
3 057 0000 00	Normal size
3 057 0000 10	1. Oversize
3 057 0000 20	2. Oversize

Part No.	Description
3 057 3058 00	SN 300x80 mm
3 057 3133 00	SN/SNK 300x150 mm
3 057 3924 00	SN/SNK 300x200 mm
3 057 3143 00	SN 355x200 mm
3 057 3968 00	SNK 367x180 mm
3 057 3970 00	SNK 367x200 mm
3 057 3960 00	SNK 420x180 mm
3 057 3966 00	SNK 420x200 mm
3 057 3010 00	SNF 420x120 mm
3 057 3912 00	SNF 420x180 mm
3 057 3913 00	SNF 420x200 mm

SAF-HOLLAND GMBH D-63856 BESSENBACH · GERMANY	
Version B9-22K01	Serial No. 11 09 156 0020
Type SBK2243-11S	Ident No. 347 96 21 7 49 01
Test Report 36110303	Perm. axle cap. stat. 9000 kg
Made in Germany	V max. 105 km/h
AN 3335528	SN 11091560020

SAF-HOLLAND GMBH D-63856 BESSENBACH · GERMANY	
Version S9-4218	Serial No. 11 09 156 0021
Type SNK4218-11S	Ident No. 147 84 60 2 58 0
Test Report TDB0381	Perm. axle cap. stat. 9000 kg
Made in Germany	V max. 105 km/h
AN 3335528	SN 11091560020

Information!

To provide technical support and parts identification we need the following information:

- Type designation of axle (Type / Version)
- Ident no.
- Prod. no. / Serial Nr.

Production no. / Serial no. of axle on RH of stub
(in direction of travel)