

Owner's Manual

DB-1407 Swivel Mount Bolt-On Drawbar

Installation, Operation and Maintenance Procedures

- For on/off-road applications
- Weight: DB-1407-L-1 (approx.) 25 lbs. (11.3 kg)
DB-1407-S-1 (approx.) 24 lbs. (10.9 kg)
DB-1407-SE-1 (approx.) 26 lbs. (11.8 kg)

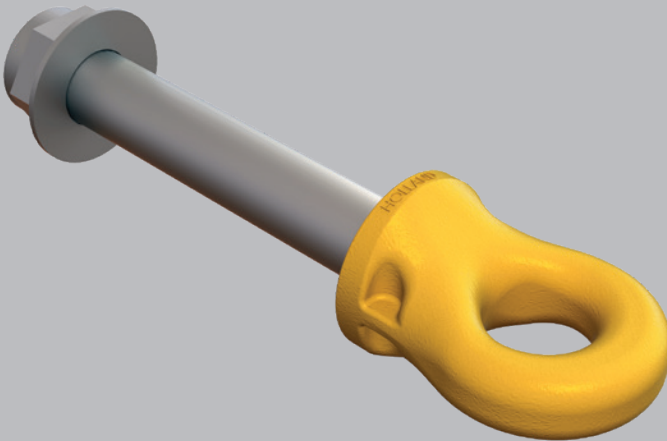

For Load Ratings, Refer to Section 3

Contents	Page
Introduction.....	2
Warranty.....	2
Notes, Cautions, and Warnings.....	2
Section 1 – General Safety Instructions	3
Exploded View and Parts List.....	4
Section 2 – Drawbar Eye Dimensions.....	5
Section 3 – Load Ratings.....	6

Contents	Page
Section 4 – Towing Applications	6
Section 5 – General Information.....	6
Section 6 – General Safety Information	6
Section 7 – Mounting Instruction	7
Section 8 – Operating Instructions	9
Section 9 – Maintenance.....	10

Introduction

This manual provides information necessary for the proper operation, maintenance, and inspection of the SAF-HOLLAND® drawbar.

NOTE: For HOLLAND® replacement components contact SAF-HOLLAND® Customer Service: 1-888-396-6501.

Warranty

Refer to the complete warranty for the country in which the product will be used. A copy of the written warranty can be downloaded from our SAF-HOLLAND® website (www.safholland.com).

Notes, Cautions, and Warnings

Read and understand all of the procedures presented in this manual before starting any work on the pintle hook.

NOTE: In the United States, work shop safety requirements are defined by federal and/or state Occupational Safety and Health Act. Equivalent laws could exist in other countries. This manual is written based on the assumption that OSHA or other applicable employee safety regulations are followed by the location where work is performed.

Proper tools **MUST** be used to perform the mounting and maintenance procedures described in this manual.

This manual contains the terms “NOTE”, “IMPORTANT”, “CAUTION”, and “WARNING” followed by important product information. These terms are defined as follows:

NOTE: Includes additional information to enable accurate and easy performance of procedures.

IMPORTANT: Includes additional information that if NOT followed could lead to hindered product performance.

CAUTION Used without the safety alert symbol, indicates a potentially hazardous situation which, if not avoided, could result in property damage.

CAUTION Indicates a potentially hazardous situation which, if not avoided, could result in minor or moderate injury.

WARNING Indicates a potentially hazardous situation which, if not avoided, could result in death or serious injury.

1. General Safety Instructions

IMPORTANT: Read this manual before using this product. Keep this manual in a safe location for future reference.

WARNING Failure to follow the instructions and safety precautions in this manual can result in equipment failure which, if not avoided, could result in death or serious injury.

Read and observe all warning and caution hazard alert messages in this publication. The information provided can help prevent death, serious injury and/or damage to components.

NOTE: In this manual, all descriptions of orientation are relative to the vehicle.

Orientation

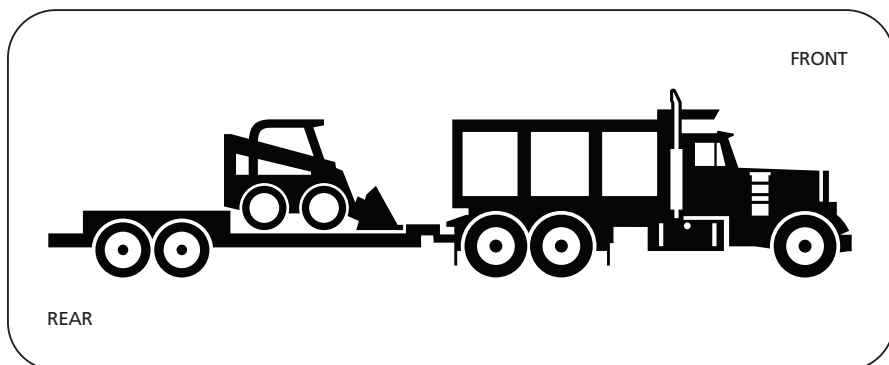

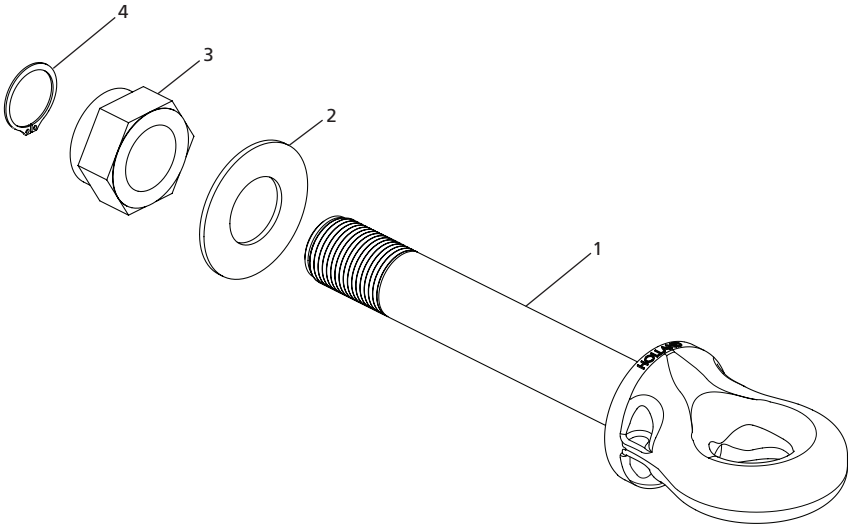

DB-1407 PARTS LIST

ITEM	DESCRIPTION	PART NUMBER	QTY.
1	Drawbar, 2-3/8" ID	XA-05833-X Refer to Table 1	1
2	Washer	XB-T-318	1
3	Nut, Lock 2" -12 UN	XB-05788	1
4	Ring, Snap	XB-05789	1

2. Drawbar Eye Dimensions

2.38" (60.3 mm) I.D. with 1.56" (39.6 mm) diameter cross section.

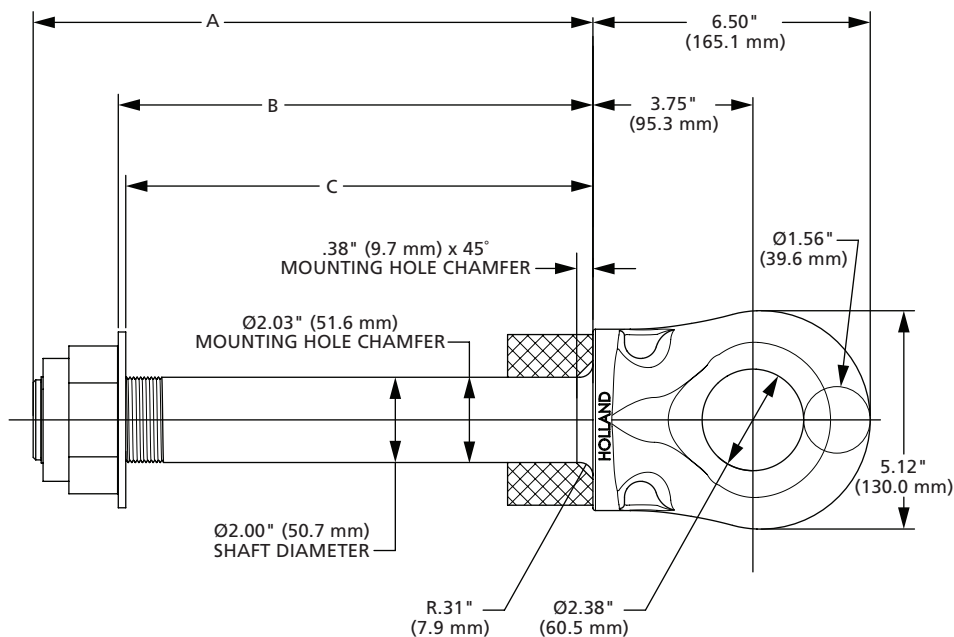

Table 1

MODEL NUMBER	DRAWBAR NUMBER	DIM "A"	DIM "B"	DIM "C"
DB-1407-L-1	XA-05833-L	12.25" (311.2 mm)	10.1" (256.5 mm)	9.9" (251.5 mm)
DB-1407-S-1	XA-05833-S	11.62" (295.2 mm)	9.4" (238.8 mm)	9.3" (236.2 mm)
DB-1407-SE-1	XA-05833-SE	13.13" (333.5 mm)	10.9" (279.9 mm)	10.8" (274.3 mm)

3. Load Ratings

Maximum GTW: 85,000 lb. (38,555 kg)

Maximum Vert. Load: 16,000 lb. (7,257 kg)

NOTE: When used for hinged tongue trailer applications:
Max Vertical: 500 lb. (227 kg)
Max GTW: 120,000 lb. (54,431 kg)

4. Towing Applications

For general on/off road towing. For severe off-road applications, reduce the above capacities by 25%.

IMPORTANT: Off-road refers to terrain on which a tow/towed vehicle will operate that is ungraded, rough or undulating, with no maintained travel surface, generally considered to NOT be part of the public road system. Examples include agricultural fields, construction sites, utility right-of-way, temporary logging roads, and what is commonly referred to as 'two-track' roads.

5. General Information

1. DO NOT modify or add to the product.
2. This product is covered by SAF-HOLLAND'S® Commercial Warranty. SAF-HOLLAND® reserves the right, without giving prior notice, to change specifications and dimensions as are altered or improved.
3. Inspect the coupling device on the tow vehicle and trailer for proper operation. DO NOT use any coupling device that DOES NOT operate properly.
4. It is the responsibility of the user to become familiar with coupling and uncoupling procedures that are provided by various governments, industry associations and mating component manufacturers instructions.

6. General Safety Information

This equipment MUST NOT be used in a careless manner.

During Operation:

1. Maintain adequate vertical (tongue) load to properly control the towed unit (generally 10% of maximum GTW) but DO NOT exceed the rated capacities.
2. DO NOT damage the coupling components. Be particularly careful during coupling and uncoupling.
3. NEVER strike any part of the item with a steel hammer.

7. Mounting Instructions

1. Use a mounting structure of sufficient strength to support the rated capacity of the drawbar in accordance with SAE J849 and SAE J847 respectively.
2. Install the drawbar in compliance with all federal, state, or local agency regulations or laws governing the installation and use of the product. Consult with these agencies prior to installation or use.
3. The mounting hole **MUST** be chamfered to provide clearance for the drawbar shank so that the drawbar mounts flush with the mounting surface. The $\varnothing 2.03$ " (51.6 mm) mounting hole and $.38$ " (9.7 mm) x 45° chamfer are detailed in **(Figure 1)**.
4. Using snap ring pliers, remove and retain the snap ring (XB-05789) **(Figure 2)**.
5. Remove and retain the lock nut (XB-05788) **(Figure 3)**.
6. Remove and retain the washer (XB-T-318) **(Figure 4)**.

Figure 1

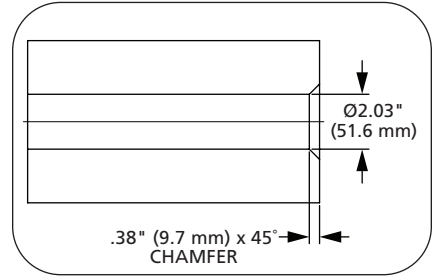

Figure 2

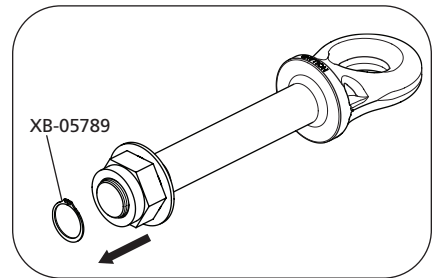

Figure 3

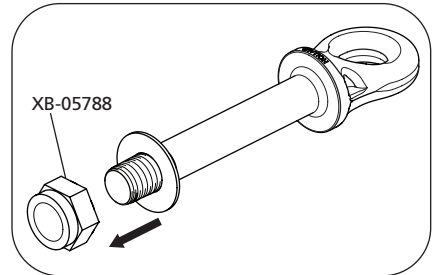
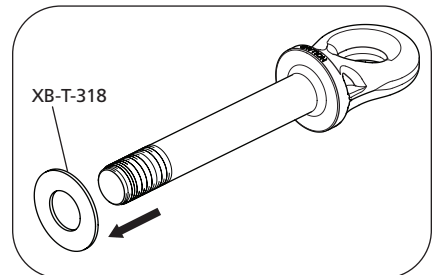

Figure 4



7. Install the drawbar into the mounting structure (**Figure 5**).
8. Install the washer (XB-T-318) onto the drawbar (**Figure 6**).
9. Install the lock nut (XB-05788) onto the drawbar (**Figure 7**).
10. Torque the lock nut to 550 ft-lbs. (746 N•m).
11. Using snap ring pliers, install the snap ring into the snap ring groove (**Figure 8**).

Figure 5

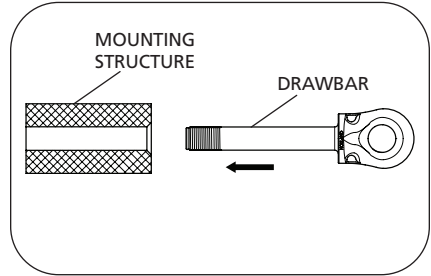

Figure 6

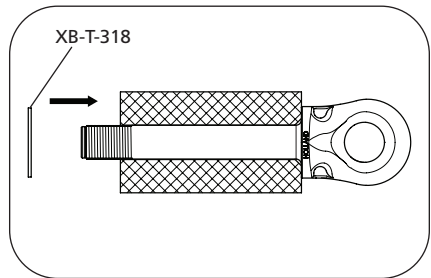

Figure 7

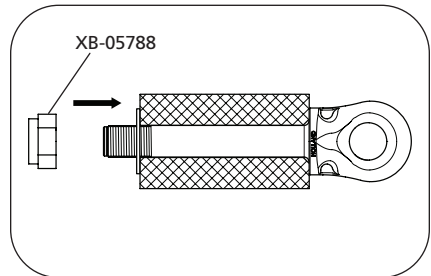
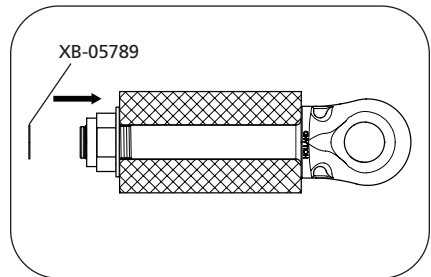

Figure 8



8. Operating Instructions

1. Before operating, inspect for wear, damaged, or missing parts and a secure mount. Correct as required before use.
2. Position the drawbar eye over the horn of the pintle and lower into place (**Figure 9 and 10**).
3. Engage the drawbar with the coupling device per the manufacturers instructions.

⚠ WARNING Failure to correctly secure the drawbar can result in separation of the pintle hook and drawbar, which, if not avoided, could result in death or serious injury.

Figure 9

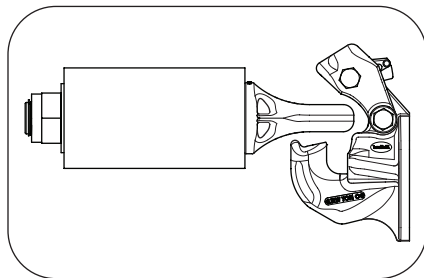
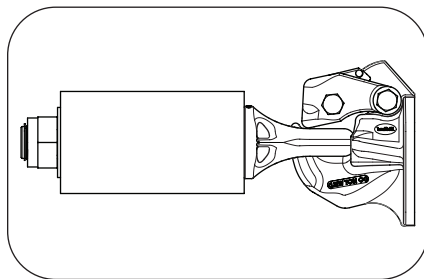

Figure 10



9. Maintenance

For proper performance, the following maintenance steps should be performed every 30,000 miles (48,280 km) or three (3) months, whichever comes first.

⚠️ WARNING Failure to inspect and maintain the drawbar may result in separation of the pintle hook and drawbar, which, if not avoided, could result in death or serious injury.

1. Clean and check for wear, damaged, or missing parts, and a secure mount. Inspect for worn, damaged or missing parts. Replace as required using only Genuine SAF-HOLLAND® parts.
2. Inspect, in particular, the coupling contact area of the drawbar. Inspect for any nicks, gouges and deformation, which may interfere with or affect the safe use of the drawbar. If cracks are visible, replace.
3. Using calipers, measure the cross section of the drawbar eye. Replace the complete product when wear exceeds 0.125" (3.18 mm) from the original surface profile. For original profile dimension (Refer to Section 3, page 6 Dimensions).
4. Inspect the drawbar mounting for proper torque (Refer to Section 7). In addition to being a safety hazard, a loose drawbar will cause excessive "chucking" and rapid wear. Reinstall or replace any drawbar which is NOT securely mounted. Verify that the snap ring is properly seated in snap ring groove.





From fifth wheel rebuild kits to suspension bushing repair kits, SAF-HOLLAND Original Parts are the same quality components used in the original component assembly.

SAF-HOLLAND Original Parts are tested and designed to provide maximum performance and durability. Will-fits, look-alikes or, worse yet, counterfeit parts will only limit the performance potential and could possibly void SAF-HOLLAND's warranty. Always be sure to spec SAF-HOLLAND Original Parts when servicing your SAF-HOLLAND product.

SAF-HOLLAND USA • 888.396.6501 • Fax 800.356.3929

www.safholland.us

SAF-HOLLAND CANADA • 519.537.3494 • Fax 800.565.7753

WESTERN CANADA • 604.574.7491 • Fax 604.574.0244

www.safholland.ca

SAF-HOLLAND MEXICO • 52.1.55.5456.8641 • Fax 52.55.58162230

www.safholland.com.mx

info@safholland.com

SAF-HOLLAND USA, INC.
1950 Industrial Blvd., Muskegon, MI 49443
www.safholland.com

